



Model ECXV40

8" - 14 gauge spun aluminum ball gold anodized.

Single sheave truck, cast aluminum revolving, non-fouling, internal halyard truck

One length #6 wire center halyard, with 2 flag snaps and covers

One 2" x 3-1/2" vinyl covered counterweight with eyelet

Beaded retaining ring

Access opening with cylinder lock

Aluminum flash collar

3000 PSI concrete

Hardwood wedges (supplied by others)

Dry sand tightly tamped after aligning pole

Foundation sleeve -16 ga hot dip galvanized steel

Steel centering wedges

1/4" Steel base plate

1/4" Steel support plate welded to grounding spike

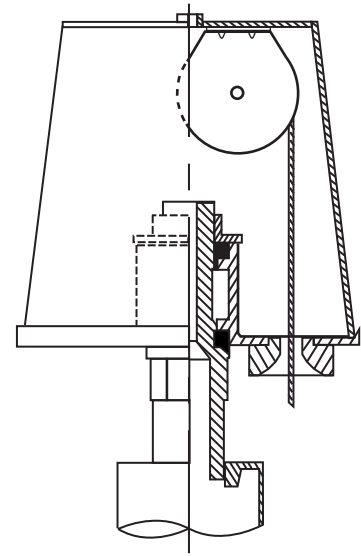

Revolving non-fouling internal halyard truck, cast aluminum body, 26 stainless steel ball bearings, and 2-1/2" diameter plated steel sheave.

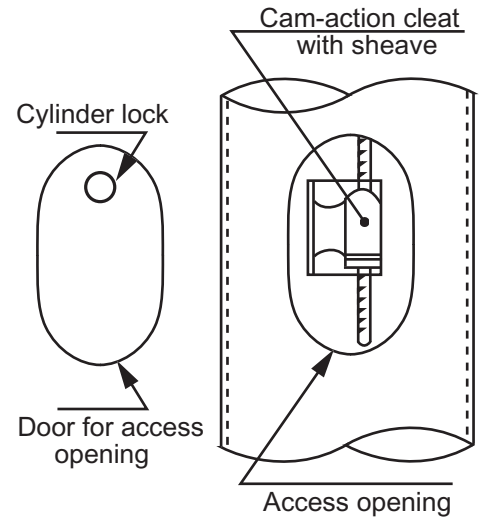

All shafts with overall length of more than 38'-6" are shipped in two sections.

Each section matched marked for field assembly. Exposed portion of jam sleeve must be **well lubricated** prior to assembly.

1-1/2" maximum shop gap allowed for field fitting (ram for tight joint)

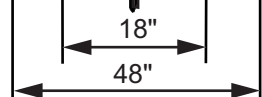
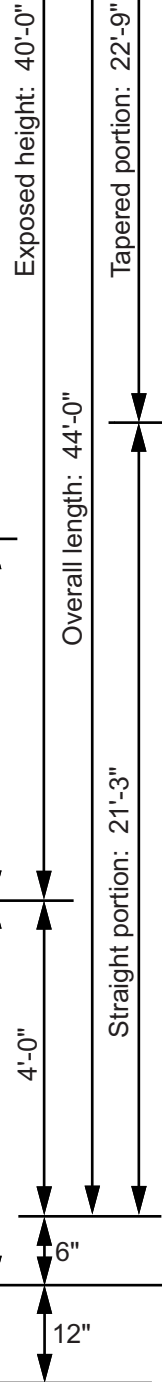
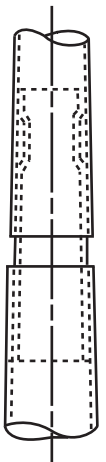

Filename: ECXV4 revolving truck Vanguard.ai

Project:	Ground set tapered aluminum flagpole: ALLOY: 6063T6	EDER FLAG	Date:
Location:	Exposed height: 40'-0"	Overall height: 44'-0"	MANUFACTURING COMPANY
Architect:	Ship in 2 section	Butt diameter: 7"	1000 W. Rawson Avenue
Contractor	Top diameter: 3-1/2"	Wall thickness: .156"	Oak Creek, WI 53154
Customer:	Finish: 100 grit polish		Job: